

2

1

FOR REFERENCE ONLY

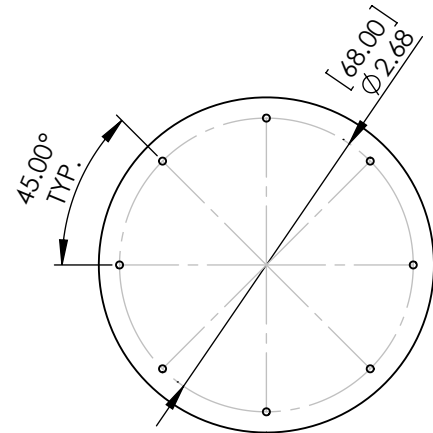
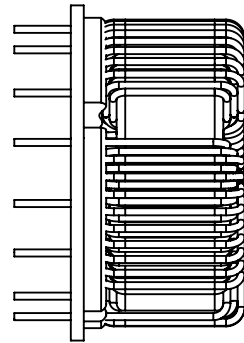
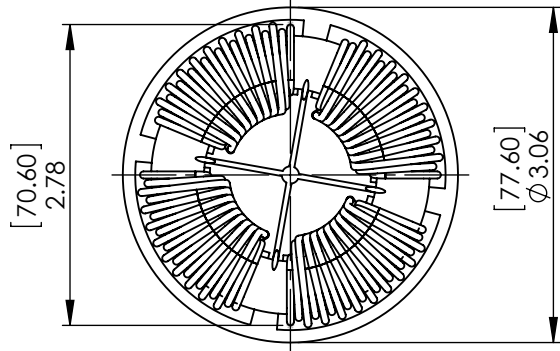
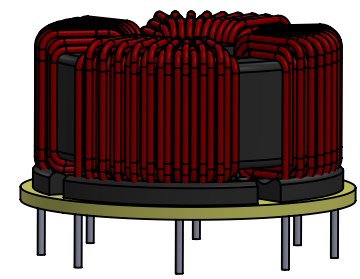
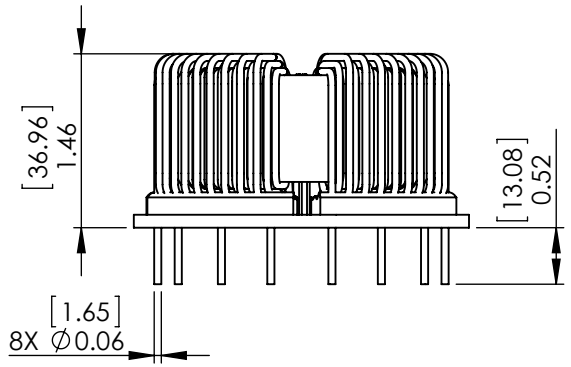

- THE PART NUMBER ON THE WEBSITE.
- 4. PLEASE REFER TO OFFICIAL AUTOCAD PDF DRAWING BY CLICKING
- 3. DIMENSIONS ARE FOR REFERENCE ONLY WITH NO TOLERANCES.

- THE SOLIDWORKS DRAWING.
- 2. DIMENSIONS SHOWN ARE FOR ONE TYPICAL UNIT USED IN
- 1. DRAWING DERIVED FROM SOLIDWORKS STEP FILE.

NOTES : UNLESS OTHERWISE SPECIFIED, READ FROM BOTTOM UP.

PROPRIETARY AND CONFIDENTIAL
 THE INFORMATION CONTAINED IN THIS DRAWING IS THE SOLE PROPERTY OF COIL WINDING SPECIALIST, INC. ANY REPRODUCTION IN PART OR AS A WHOLE WITHOUT THE WRITTEN PERMISSION OF COIL WINDING SPECIALIST, INC. IS PROHIBITED.

UNLESS OTHERWISE SPECIFIED:		NAME	DATE
DIMENSIONS ARE IN INCHES	DRAWN	JJ	07/21/20
TOLERANCES:	CHECKED	TN	07/21/20
FRACTIONAL ±	ENG APPR.	JL	07/21/20
ANGULAR: MACH ± BEND ±	MFG APPR.	JL	07/21/20
TWO PLACE DECIMAL ±	Q.A.	JM	07/21/20
THREE PLACE DECIMAL ±	COMMENTS:		
INTERPRET GEOMETRIC TOLERANCING PER:			
MATERIAL			
FINISH			
DO NOT SCALE DRAWING			

PDF DERIVED FROM SOLIDWORKS		
TITLE: SolidWorks Version of Nanocrystalline Inductor Four-Phase Common Mode Choke Horizontal Mount		
SIZE	DWG. NO.	REV
A	FPB-763U-B12A-SW	A
SCALE: 1:1.75	WEIGHT:	SHEET 1 OF 1

2

1