

Thermal and Electromagnetics simulation – Part # ES55246-300M-180AH – Current rated 180A @ 10kHz

Current 30% (54 A)
No Airflow
Natural convection

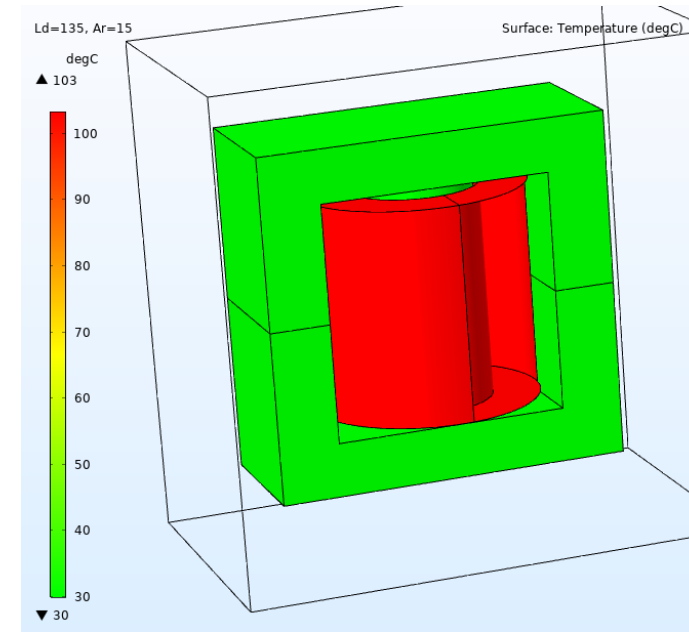

Current 75% (135A)
15 W/(m²K) or 3 m/s
air flow.

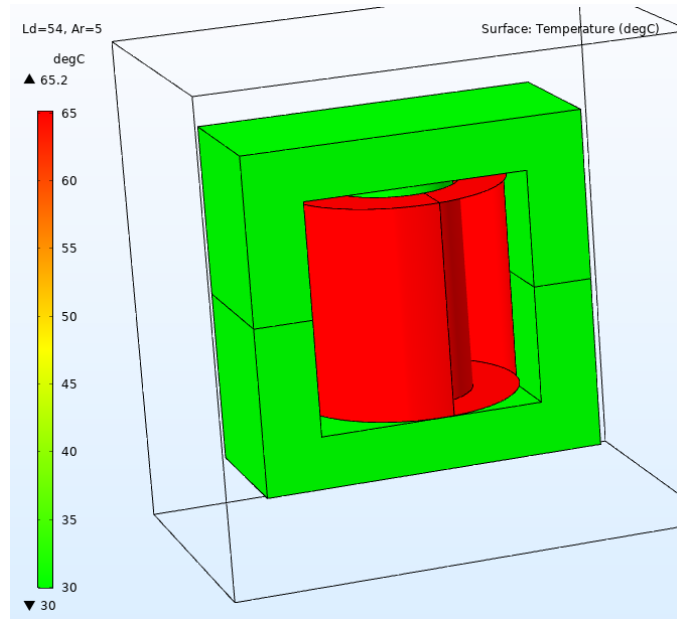
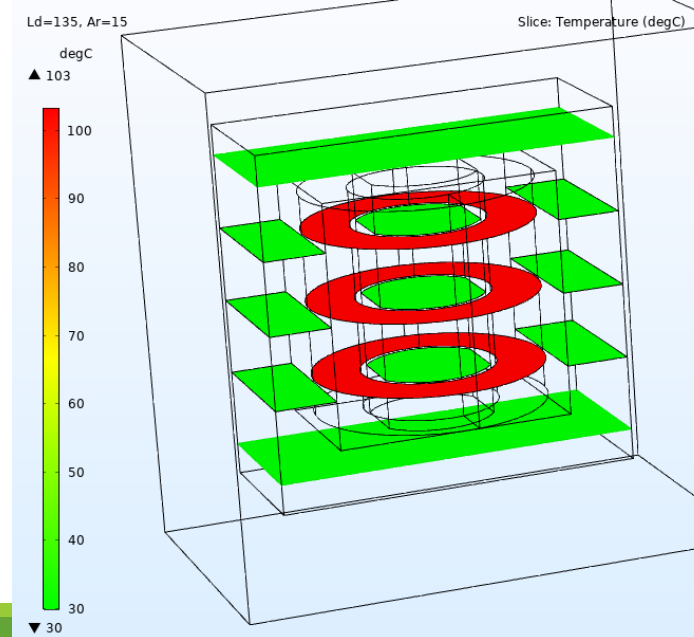
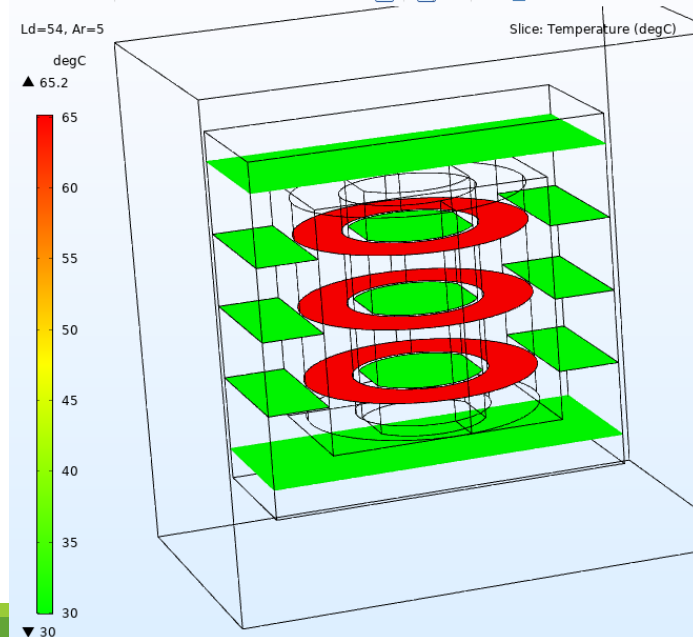

Thermal and Electromagnetics simulation – Part # ES55246-300M-180AH – Current rated 180A @ 10kHz

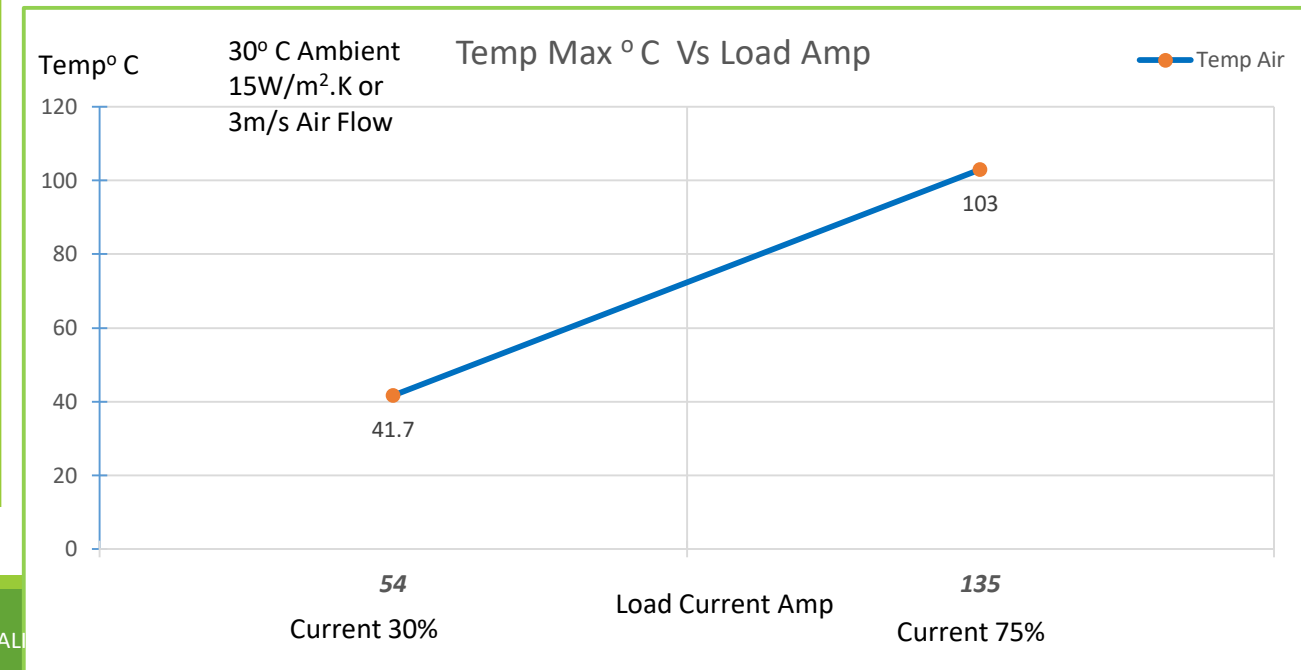
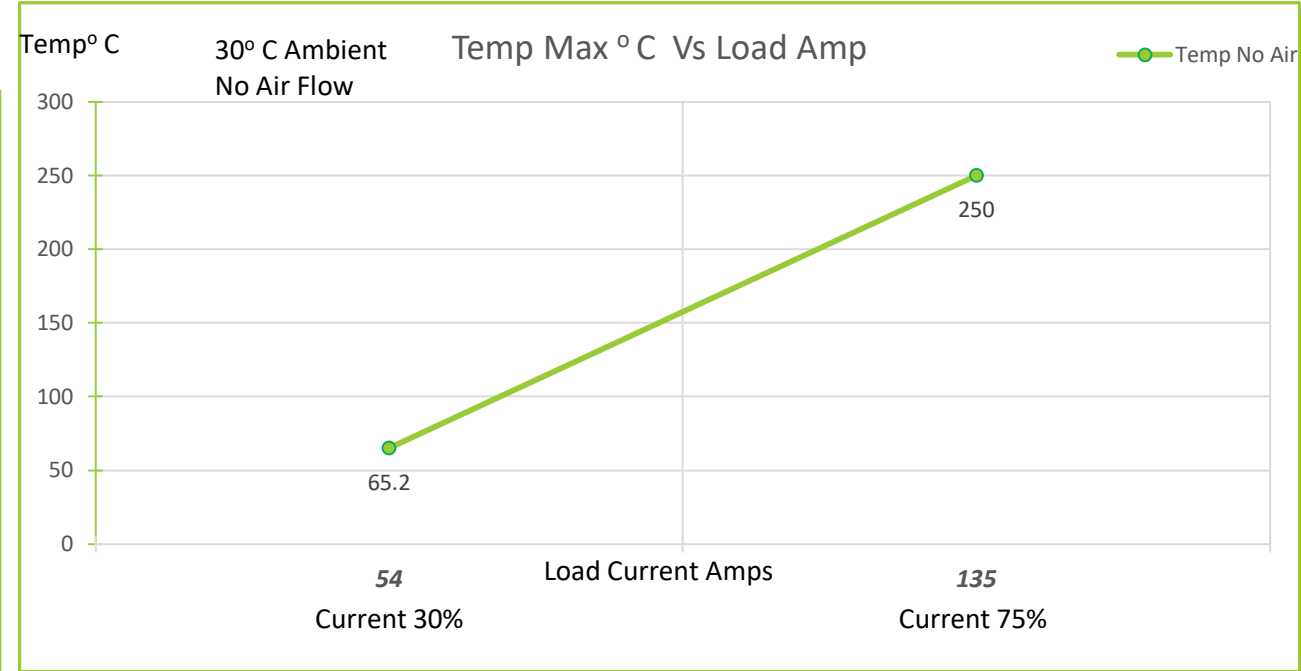
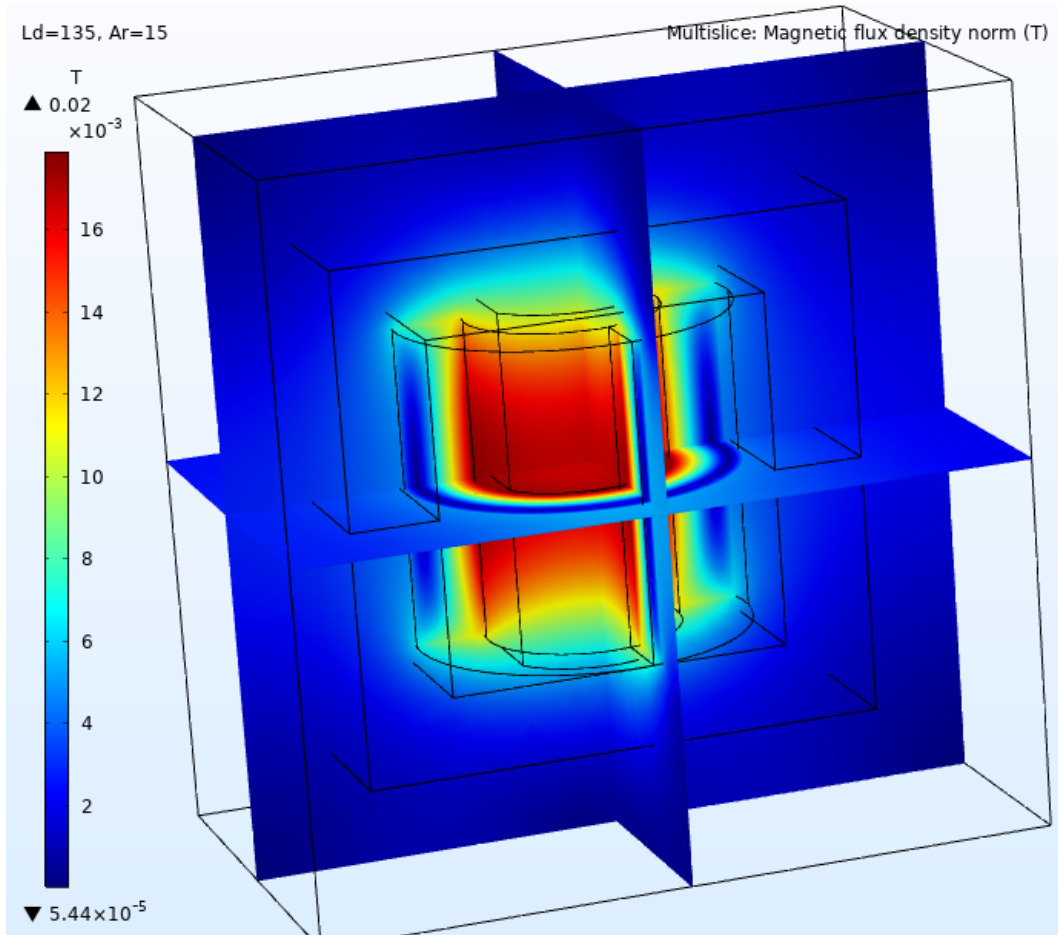

Thermal and Electromagnetics simulation – Part # ES55246-300M-180AH – Current rated 180A @ 10kHz

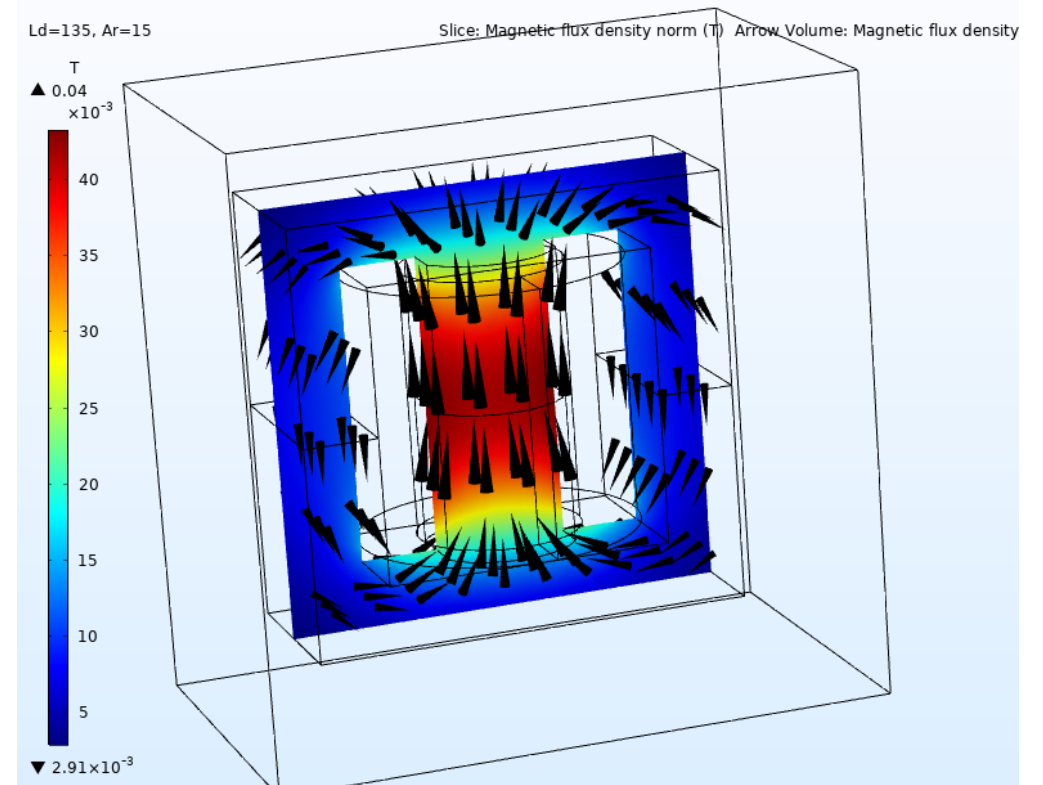
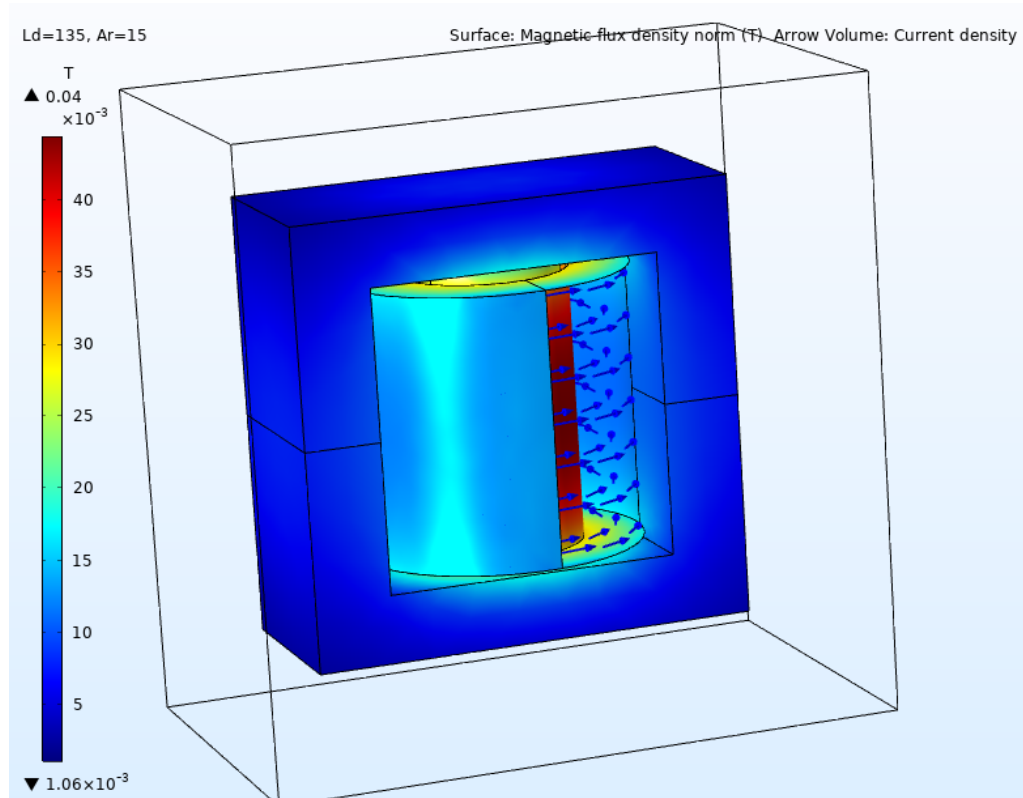

Abbreviations

Ld	: Current rated Amps
Ar	: Airflow
W/m ² .K	: Watts / Sq meter .Kelvin – Heat Convection rate
m/s	: Meter/ Second - Airflow
degC	: Temperature in Deg C
T	: Tesla – Magnetic Flux density
Temp	: Temperature
Temp max:	Temperature Maximum
Amb	: Ambient Temperature
Amps	: Ampere Load current.
Slice	: Sectional view

Disclaimer :

- Simulation MODEL is an effective tool for evaluating product performance by simulation; however, it does not simulate product performance in all test environments and is not intended to be a replacement for testing of the actual device by means of a test board or otherwise.
- Simulation results are for reference purposes only; CUSTOMER shall perform thorough testing using the actual device.